

KOMATSU

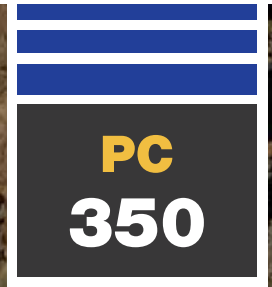

Hydraulic Excavator **PC350LC/NLC-8**

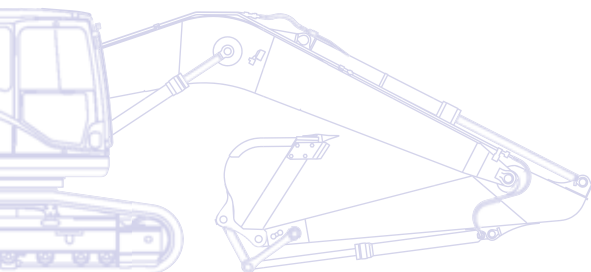

ENGINE POWER

194 kW / 260 HP @ 1.950 rpm

OPERATING WEIGHT

PC350LC-8: 34.430 - 36.390 kg

PC350NLC-8: 35.320 - 36.090 kg

BUCKET CAPACITY

max. 2,66 m³

Walk-Around

The Komatsu Dash 8 crawler excavators set new worldwide standards for construction equipment. Operator safety and comfort is a focal point in their design, and their outstanding performance and specifications will contribute directly to the success of your business. With standard auxiliary hydraulic systems and quick-coupler power lines, these machines are ready to take on any job, whenever and wherever you need it done. Safely rely on Komatsu's 80 years of experience and commitment to Quality and Durability: your Dash 8 crawler excavator will quickly become your number one business partner.

Powerful and environmentally friendly

- Low consumption ecot3 engine
- Komatsu integrated hydraulic system
- Eco-gauge and idle caution
- Reduced wastage

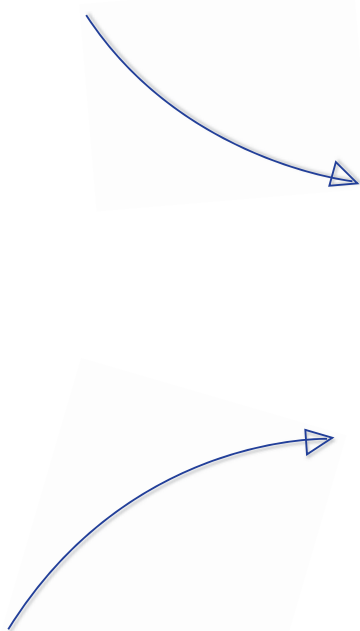

Total versatility

- Ideal for a wide range of applications
- 5 working modes
- Two-mode boom control
- Wide choice of options
- Built-in versatility



PC350-8

ENGINE POWER

194 kW / 260 HP @ 1.950 rpm

OPERATING WEIGHT

PC350LC-8: 34.430 - 36.390 kg

PC350NLC-8: 35.320 - 36.090 kg

BUCKET CAPACITY

max. 2,66 m³



Highest safety standards

- Safe SpaceCab™
- Rear view camera
- Optimal jobsite safety
- Safe access, easy maintenance
- Falling Object Protection System (FOPS) optional

First-class operator comfort

- Wide, spacious cab
- Low noise design
- Low vibration levels
- Pressurised cab
- Large, widescreen TFT monitor panel



KOMTRAX

Komatsu Satellite
Monitoring System

Quality you can rely on

- Reliable and efficient
- Rugged design
- Komatsu-quality components
- Extensive dealer support network

Total Versatility

Ideal for a wide range of applications

Powerful and precise, the Komatsu PC350-8 is equipped to efficiently carry out any task your business requires. On big sites or small, for digging, trenching, landscaping or site preparation, the Komatsu original equipment hydraulic system always ensures maximum productivity and control.

5 working modes

Power, Lifting, Breaker, Attachment, and Economy.

The PC350-8 features 5 selectable working modes that optimise performance and fuel usage. The Economy mode can be adjusted for an ideal balance between power and economy to match your work. The oil flow delivered to hydraulic attachments is adjustable directly on the class-leading wide screen monitor panel.

Built-in versatility

To allow the use of many attachments, such as buckets, breakers or demolition tools, a power supply for a hydraulic quick coupler with adjustable pressure settings, and an additional hydraulic circuit controlled by a foot pedal and a sliding joystick push button are standard on the PC350-8. A second optional auxiliary line is also available for attachments that require extra hydraulic actuation.

A wide choice of options

With a choice of different styles of boom, arm and undercarriage, you can configure the PC350-8 to match specific demands for transport, working envelope or duty. The excavator can for instance be equipped with Komatsu's own Super Long Front end equipment, to let the machine work in otherwise inaccessible areas. Extra hydraulic arrangements are available for every boom and arm configuration, making sure that the machine always contributes strongly to your business.

Two-mode boom control

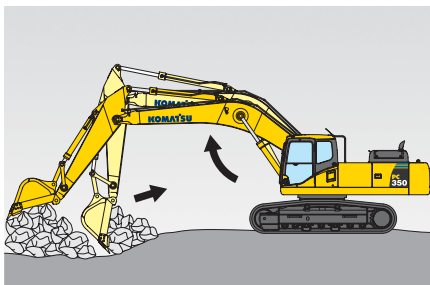

*Smooth mode
Boom floats upward, reducing lifting of machine front. This facilitates gathering blasted rock and scraping down operations.*

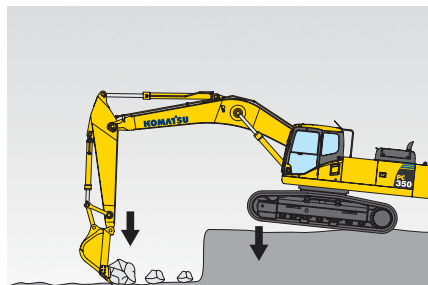

*Power mode
Boom pushing force is increased, ditch digging and box digging operation on hard ground are improved.*





Powerful and Environmentally Friendly

Low consumption ecot3 engine

The Komatsu SAA6D114E-3 engine provides high torque, a better performance at low speed and low fuel consumption. This ecot3 engine features a new combustion chamber design with optimised ignition and combustion timing. The operating pressure of the new common rail system was increased for improved injection and fuel efficiency. The air-to-air charge cooler reduces the temperature of the compressed air supplied by the turbo charger to the cylinders, and further improves fuel consumption.

Meets EU Stage IIIA

The new Komatsu ecot3 engine technology reduces NOx and particle emissions, fuel consumption and noise level. The Komatsu SAA6D114E-3 engine is certified for EPA Tier III and EU Stage IIIA emission regulations. To further reduce the machine's emissions, a Diesel Particulate Filter is also available.

Komatsu integrated hydraulic system

The PC350-8 is a highly responsive and productive machine with all major hydraulic parts designed and manufactured by Komatsu. The electronic Closed Load Sensing hydraulic System (CLSS) offers complete control during individual or combined movements – without sacrificing performance or productivity.

Eco-gauge and idle caution

The unique ECO-gauge helps the operator reduce emissions and fuel consumption for environmentally friendly and energy saving operations. And to further avoid wasting fuel when the machine is not actually working, a standard-fit idle caution is displayed if the engine idles for 5 minutes or more.

Komatsu SAA6D114E-3



Eco-gauge



Idle caution





Reduced wastage

To avoid spillage of excess grease – and prolong the life of your machine – the PC350-8 can be equipped with an automatic greasing system that provides precisely the correct amount of grease when and where it's required.



First-Class Operator Comfort

Wide spacious cab

The newly designed, wide and spacious cab includes a heated air suspension seat with a reclining backrest. The seat height and longitudinal inclination are easily adjusted with a pull-up lever. You can also set the operational posture of the armrest and the position of the console or recline the seat all the way and place it into a fully flat state with the headrest attached.

Pressurised cab

An automatic air conditioner, an air filter and a positive internal air pressure (60 Pa) combine to prevent external dust from entering the cab.

Low noise design

Komatsu Dash 8 crawler excavators feature the lowest in-class external noise levels and are especially well-suited for work in confined spaces or urban areas. Reduced fan speed, a large capacity radiator, and the optimal usage of sound insulation and of sound absorbing materials help to make noise levels inside Dash 8 excavators comparable to those inside an executive car.

Cab damper mounting

The built-in stability of the Komatsu PC350-8, combined with a highly rigid deck and a sprung multi-layer viscous mount system, drastically reduces vibration levels for the operator.



Automatic air conditioner



Hot and cool box



Joysticks with proportional control button for attachments





Large, widescreen TFT monitor

To enable safe, accurate and smooth work, the user friendly monitor is the highly intuitive user interface for the machine's Equipment Management and Monitoring System (EMMS). Multilingual and with all essential information available at a glance, it features simple and easy to operate switches and multifunction keys that provide the operator with fingertip access to a wide range of functions and operating information.





Highest Safety Standards

Safe SpaceCab™

Specifically designed for Komatsu excavators, the Dash 8 cab has a tubular steel frame. It provides very high shock absorbency, impact resistance and durability. The seat belt is designed to keep the operator in the safety zone of the cab in the event of a roll-over. At your request, the Komatsu PC350-8 can also be fitted with an ISO 10262 Level 2 Falling Object Protective System (FOPS).

Safe and easy maintenance

Thermal guards are placed around high temperature parts of the engine. The fan belt and pulleys are well protected and in case of damage, fire risk is reduced by a pump/engine partition that prevents hydraulic oil from spraying onto the engine.

Optimal job site safety

Safety features on the Komatsu PC350-8 comply with the latest industry standards and work together as a system to minimise risks to personnel in and around the machine. An audible travel alarm further promotes job site safety. Very durable anti-slip plates – with additional high friction covering – maintain long term traction performance.

Rear view camera

A standard fitment camera gives an exceptionally clear view of the rear work zone on the wide-screen monitor panel. Large mirrors on both sides ensure that machine visibility meets the latest ISO standards.



Rear view camera

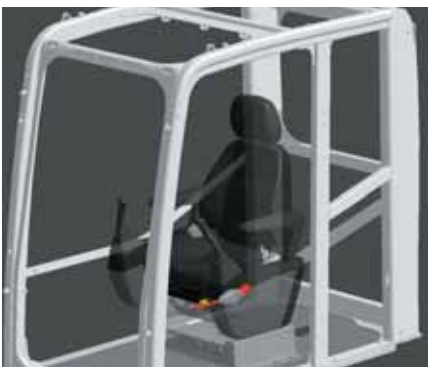

Safe SpaceCab™



Anti-slip plates



Quality You Can Rely On

Reliable and efficient

Productivity is the key to success – all major components of the PC350-8 are designed and directly manufactured by Komatsu. Essential machine functions are perfectly matched for a highly reliable and productive machine.

Rugged design

Maximum toughness and durability – along with top class customer service – are the cornerstones of Komatsu's philosophy. Single piece plates and castings are used in key areas of the machine's structure for good load distribution. Highly durable rubbing strips on the underside of the arm protect the structure from material falling from the bucket.

Komatsu-quality components

With the latest computer design techniques and a thorough test programme, Komatsu's global know-how produces machines that are designed, manufactured and tested to meet your highest standards.

Extensive dealer support network

The extensive Komatsu distribution and dealer network is standing by to help keep your fleet in optimum condition. Customised servicing packages are available, with express availability of spare parts, to make sure that your Komatsu will continue to perform at its peak.



Cast boom foot



Single piece boom plates



Komatsu Satellite Monitoring System



KOMTRAX™ is a revolutionary machine tracking system designed to save you time and money. You can now monitor your equipment anytime and anywhere. Use valuable machine data received via the KOMTRAX™ web site to optimise your maintenance planning and machine performances.

KOMTRAX™ can assist you with:

Full machine monitoring

Get detailed operation data to know when your machines are used and how productive they are.

Total Fleet Management

Keep track of the location of your machines at all times and discourage unapproved usage or theft.

Complete machine status

Receive warnings, alerts and cautions, via a web site or by e-mail, to help with maintenance planning and for longer machine life.

For further details on KOMTRAX™, please ask your Komatsu dealer for the latest KOMTRAX™ brochure.





Machine working time - With the "daily working record" chart, get precise engine running time data: when your machine was started and when it was shut down, as well as total engine running time.



Maintenance planning - To increase productivity and improve maintenance planning, alerts indicate when items such as filters or oil must be replaced.



Fleet location - The machine list instantly locates all your machines, even those in other countries.



Machine tracking during transport - When your machine is transported, KOMTRAX™ sends travel messages to the web site or by e-mail to inform you of its progress, and confirms when it reaches its destination.



Alarm notifications - You can receive notification of alarms both via the KOMTRAX™ website and by e-mail.



Added security - The "engine lock" feature allows to program when a machine's engine can be started. And with "geo-fence", KOMTRAX™ sends notification every time your machine moves in or out of a predetermined operating area.



Easy Maintenance

Side-by-side cooling

Since the radiator, aftercooler and oil cooler are arranged in parallel, it is easy to clean, remove and install them.



Easy access to the engine oil filter and fuel drain valve

The engine oil filter and fuel drain valve are mounted remotely to improve accessibility.



Long-life oil filters

The hydraulic oil filter uses high-performance filtering material for long element replacement intervals, which significantly reduces maintenance costs.



Water separator

This is standard equipment which removes any water that has become mixed with the fuel, preventing fuel system damage.



Washable floor

The floor is easy to keep clean. The gently inclined surface has a flanged floormat and drainage holes to facilitate runoff.



Flexible warranty

When you purchase Komatsu equipment, you gain access to a broad range of programmes and services that have been designed to help you get the most from your investment. For example, Komatsu's Flexible Warranty Programme provides a range of extended warranty options on the machine and its components. These can be chosen to meet your individual needs and activities. This programme is designed to help reduce total operating costs.

ENGINE

Model	Komatsu SAA6D114E-3
Type.....	Common rail direct injection, water-cooled, emissionised, turbocharged, after-cooled diesel
Engine power	
at rated engine speed	1.950 rpm
ISO 14396	194 kW / 260 HP
ISO 9249 (net engine power)	184 kW / 247 HP
No. of cylinders	6
Bore x stroke	114 x 135 mm
Displacement.....	8,27 ltr
Battery	2 x 12 V/140 Ah
Alternator.....	24 V/60 A
Starter motor	24 V/11 kW
Air filter type	Double element type with monitor panel dust indicator and auto dust evacuator
Cooling	Suction type cooling fan with radiator fly screen

HYDRAULIC SYSTEM

Type.....	HydrauMind. Closed-centre system with load sensing and pressure compensation valves
Additional circuits.....	Depending on the specification up to 2 additional circuits can be installed
Main pump	2 variable displacement piston pumps supplying boom, arm, bucket, swing and travel circuits
Maximum pump flow.....	2 x 268 ltr/min
Relief valve settings	
Implement.....	380 bar
Travel	380 bar
Swing	285 bar
Pilot circuit.....	33 bar

UNDERCARRIAGE

Construction.....	X-frame centre section with box section track frames
Track assembly	
Type	Fully sealed
Shoes (each side)	48
Tension	Combined spring and hydraulic unit
Rollers	
Track rollers (each side).....	8
Carrier rollers (each side).....	2

SWING SYSTEM

Type.....	Axial piston motor driving through planetary double reduction gearbox
Swing lock.....	Electrically actuated wet multi-disc brake integrated into swing motor
Swing speed.....	0 - 9,5 rpm
Swing torque	102,9 kNm

DRIVES AND BRAKES

Steering control.....	2 levers with pedals giving full independent control of each track
Drive method.....	Hydrostatic
Travel operation.....	Automatic 3-speed selection
Gradeability	70%, 35°
Max. travel speeds	
Lo / Mi / Hi	3,2 / 4,5 / 5,5 km/h
Maximum drawbar pull.....	26.900 kg
Brake system.....	Hydraulically operated discs in each travel motor

SERVICE REFILL CAPACITIES

Fuel tank.....	605 ltr
Radiator	32 ltr
Engine oil.....	35 ltr
Swing drive.....	16,5 ltr
Hydraulic tank	188 ltr
Final drive (each side).....	9 ltr

ENVIRONMENT

Engine emissions	Fully complies with EU Stage IIIA and EPA Tier III exhaust emission regulations
Noise levels	
LwA external	105 dB(A) (2000/14/EC Stage II)
LpA operator ear.....	71 dB(A) (ISO 6396 dynamic test)

OPERATING WEIGHT (APPR.)

	MONO BOOM				TWO-PIECE BOOM			
	PC350LC-8		PC350NLC-8		PC350LC-8		PC350NLC-8	
Triple grouser shoes	Operating weight	Ground pressure	Operating weight	Ground pressure	Operating weight	Ground pressure	Operating weight	Ground pressure
600 mm	34.420 kg	0,66 kg/cm ²	34.310 kg	0,65 kg/cm ²	35.430 kg	0,67 kg/cm ²	35.320 kg	0,67 kg/cm ²
700 mm	34.800 kg	0,57 kg/cm ²	34.690 kg	0,57 kg/cm ²	35.810 kg	0,58 kg/cm ²	35.110 kg	0,57 kg/cm ²
800 mm	35.180 kg	0,50 kg/cm ²	35.070 kg	0,50 kg/cm ²	36.200 kg	0,52 kg/cm ²	36.090 kg	0,52 kg/cm ²
850 mm	35.370 kg	0,48 kg/cm ²	-	-	36.390 kg	0,49 kg/cm ²	-	-

Operating weight, including 2,6 m arm, 1.700 kg bucket, operator, lubricant, coolant, full fuel tank and the standard equipment.

Dimensions & Performance Figures

MACHINE DIMENSIONS	PC350LC-8	PC350NLC-8
A Overall width of upper structure	2.995 mm	2.995 mm
B Overall height of cab	3.100 mm	3.100 mm
C Overall length of basic machine	5.882 mm	5.882 mm
D Tail length	3.405 mm	3.405 mm
Tail swing radius	3.450 mm	3.450 mm
E Clearance under counterweight	1.186 mm	1.186 mm
F Machine tail height	2.580 mm	2.580 mm
G Ground clearance	498 mm	498 mm
H Tumbler centre distance	4.030 mm	4.030 mm
I Track length	4.955 mm	4.955 mm
J Track gauge	2.590 mm	2.390 mm
K Track shoe width	600, 700, 800, 850 mm	600, 700, 800, 850 mm
L Overall track width with 600 mm shoe	3.190 mm	2.990 mm
Overall track width with 700 mm shoe	3.290 mm	3.090 mm
Overall track width with 800 mm shoe	3.390 mm	3.190 mm
Overall track width with 850 mm shoe	3.440 mm	-

MONO BOOM

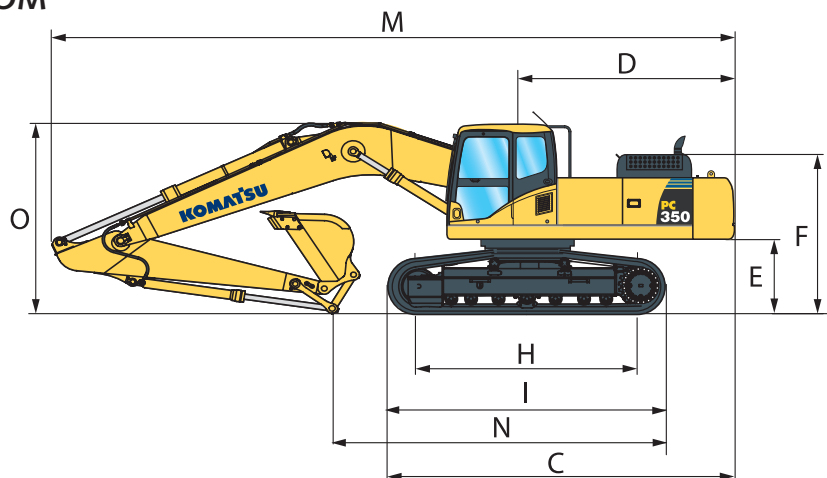
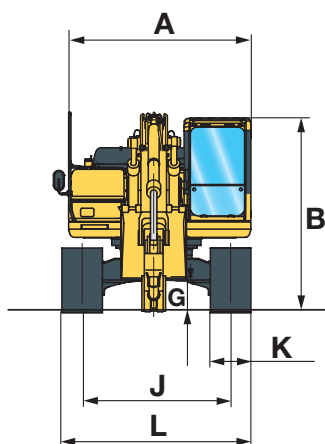

TWO-PIECE BOOM

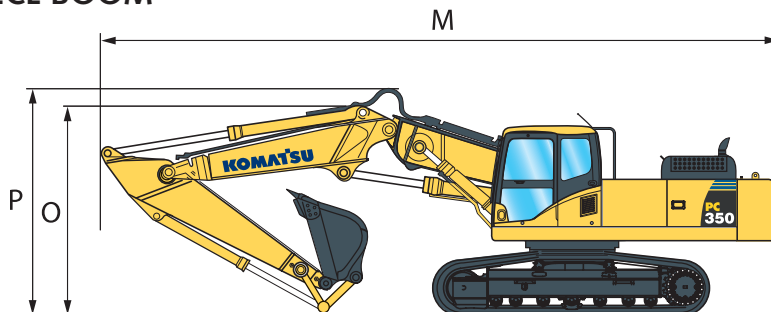

TRANSPORT DIMENSIONS	MONO BOOM				TWO-PIECE BOOM			
Arm length	2,2 m	2,6 m	3,2 m	4,0 m	2,2 m	2,6 m	3,2 m	4,0 m
M Transport length	11.290 mm	11.180 mm	11.140 mm	11.170 mm	11.275 mm	11.215 mm	11.145 mm	10.930 mm
N Length on ground (transport)	7.155 mm	6.760 mm	5.930 mm	5.475 mm	7.740 mm	7.095 mm	6.420 mm	6.205 mm
O Overall height (to top of boom)	3.400 mm	3.410 mm	3.280 mm	3.760 mm	3.345 mm	3.315 mm	3.420 mm	3.005 mm
P Overall height (to top of hose)	-	-	-	-	3.640 mm	3.615 mm	3.710 mm	4.160 mm

BUCKET AND ARM COMBINATIONS

MONO BOOM			PC350LC-8				PC350NLC-8			
Width (without side cutters)	Capacity (SAE, PCSA heaped)	Weight (without side cutters)	2,2 m	2,6 m	3,2 m	4,0 m	2,2 m	2,6 m	3,2 m	4,0 m
800 mm	0,85 m ³	880 kg	○	○	○	○	○	○	○	○
1.000 mm	1,13 m ³	1.010 kg	○	○	○	○	○	○	○	○
1.200 mm	1,42 m ³	1.160 kg	○	○	○	□	○	○	○	□
1.400 mm	1,75 m ³	1.290 kg	○	○	○	□	○	○	○	□
1.500 mm	1,87 m ³	1.350 kg	○	○	○	□	○	○	○	□
1.600 mm	2,02 m ³	1.400 kg	○	○	○	△	○	○	○	△
1.800 mm	2,32 m ³	1.520 kg	○	○	○	–	○	○	○	–
2.000 mm	2,66 m ³	1.664 kg	○	○	□	–	○	□	□	–

TWO-PIECE BOOM			PC350LC-8				PC350NLC-8			
Width (without side cutters)	Capacity (SAE, PCSA heaped)	Weight (without side cutters)	2,2 m	2,6 m	3,2 m	4,0 m	2,2 m	2,6 m	3,2 m	4,0 m
800 mm	0,85 m ³	880 kg	○	○	○	○	○	○	○	○
1.000 mm	1,13 m ³	1.010 kg	○	○	○	□	○	○	○	□
1.200 mm	1,42 m ³	1.160 kg	○	○	○	□	○	○	○	□
1.400 mm	1,75 m ³	1.290 kg	○	○	○	△	○	○	○	△
1.500 mm	1,87 m ³	1.350 kg	○	○	○	△	○	○	○	△
1.600 mm	2,02 m ³	1.400 kg	○	○	○	–	○	○	○	–
1.800 mm	2,32 m ³	1.520 kg	○	○	○	–	○	○	□	–
2.000 mm	2,66 m ³	1.664 kg	○	○	□	–	○	□	△	–

Specifications and equipment may vary according to regional availability. Please consult with your distributor for the correct selection of buckets and attachments to suit the application. The recommendations are given as a guide only, based on typical operating conditions.

- Material weight up to 1,8 t/m³
- Material weight up to 1,5 t/m³
- △ Material weight up to 1,2 t/m³
- Not usable

BUCKET AND ARM FORCE

Arm length	2,2 m	2,6 m	3,2 m	4,0 m
Bucket digging force	24.700 kg	24.700 kg	21.600 kg	21.600 kg
Bucket digging force at PowerMax	26.400 kg	26.400 kg	23.100 kg	23.100 kg
Arm crowd force	22.400 kg	19.100 kg	16.300 kg	13.700 kg
Arm crowd force at PowerMax	24.000 kg	20.500 kg	17.400 kg	14.700 kg

Working Range

MONO BOOM

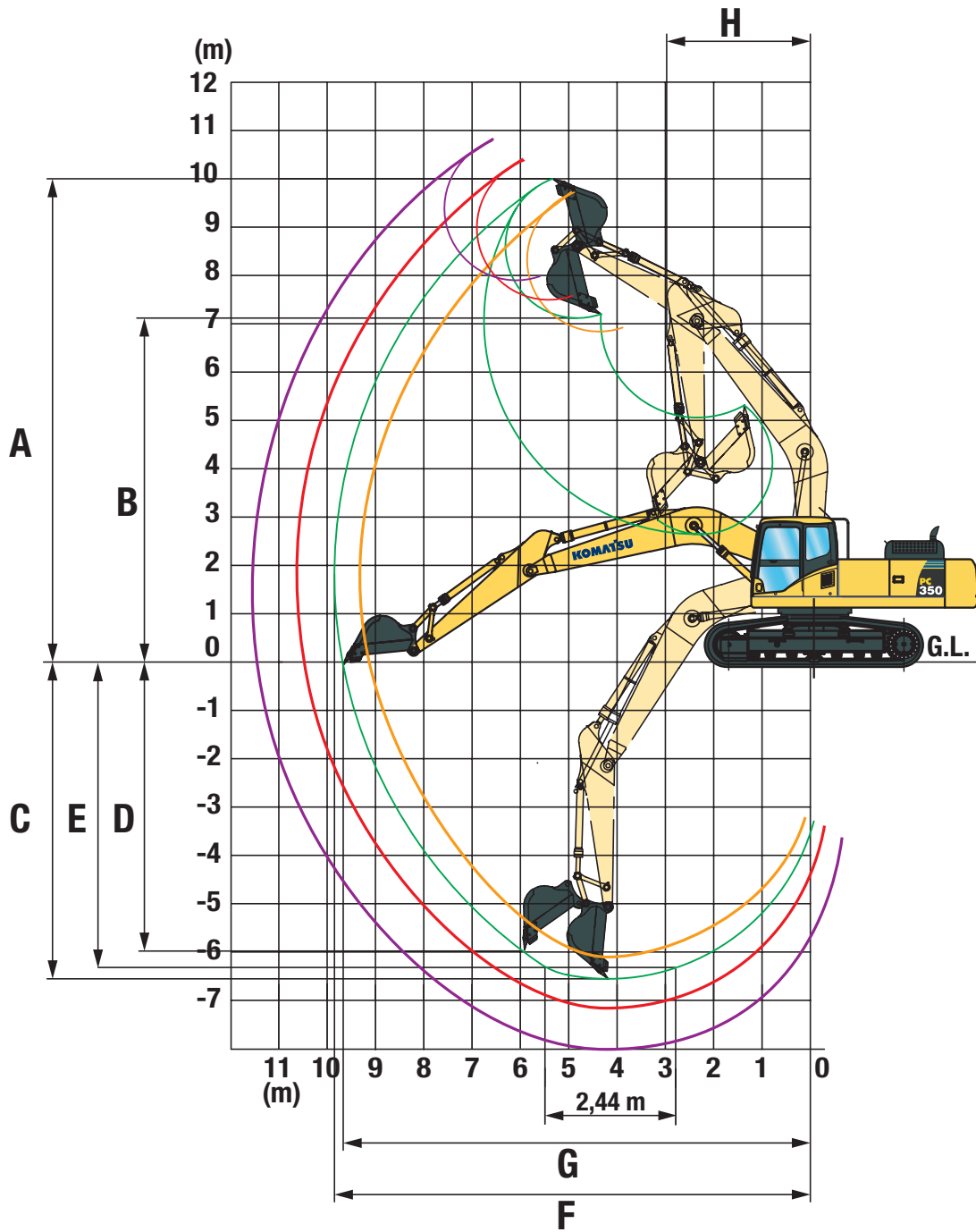

ARM LENGTH	2,2 m	2,6 m	3,2 m	4,0 m
A Max. digging height	9.580 mm	9.965 mm	10.210 mm	10.550 mm
B Max. dumping height	6.595 mm	6.895 mm	7.110 mm	7.490 mm
C Max. digging depth	6.355 mm	6.705 mm	7.380 mm	8.180 mm
D Max. vertical wall digging depth	5.120 mm	5.880 mm	6.480 mm	7.280 mm
E Max. digging depth of cut for 2,44 m level	6.130 mm	6.520 mm	7.180 mm	8.045 mm
F Max. digging reach	10.155 mm	10.550 mm	11.100 mm	11.900 mm
G Max. digging reach at ground level	9.950 mm	10.355 mm	10.920 mm	11.730 mm
H Min. swing radius	4.390 mm	4.400 mm	4.310 mm	4.320 mm



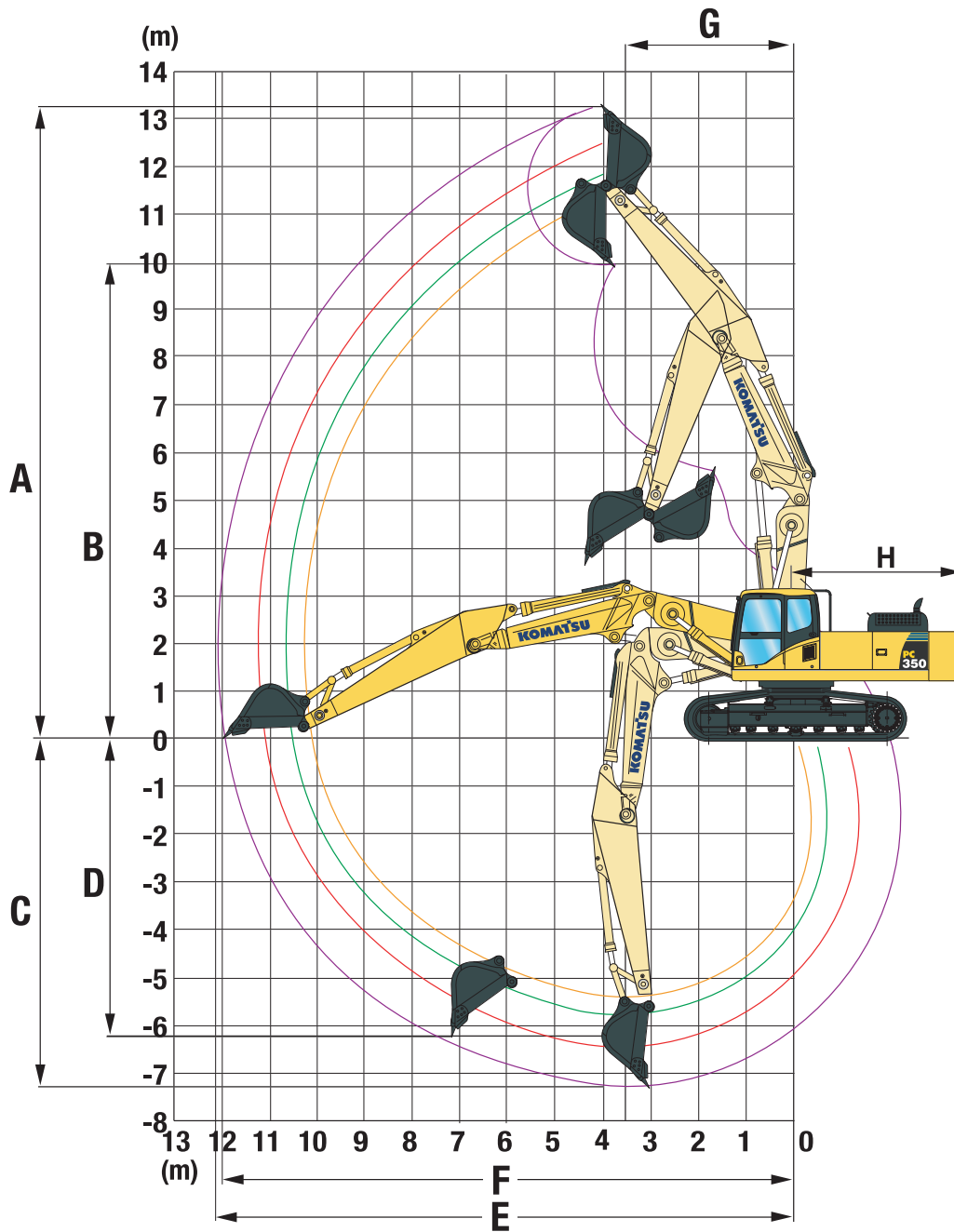













TWO-PIECE BOOM

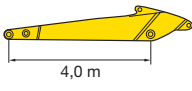

ARM LENGTH	2,2 m	2,6 m	3,2 m	4,0 m
A Max. digging height	11.590 mm	12.080 mm	12.515 mm	13.260 mm
B Max. dumping height	8.345 mm	8.755 mm	9.195 mm	9.930 mm
C Max. digging depth	5.425 mm	5.815 mm	6.435 mm	7.275 mm
D Max. vertical wall digging depth	4.260 mm	4.860 mm	5.410 mm	6.240 mm
E Max. digging reach	10.280 mm	10.710 mm	11.285 mm	12.120 mm
F Max. digging reach at ground level	10.075 mm	10.515 mm	11.100 mm	11.950 mm
G Min. swing radius	3.095 mm	3.160 mm	3.120 mm	3.540 mm
H Tail swing radius	3.405 mm	3.405 mm	3.405 mm	3.405 mm

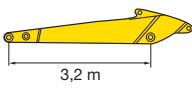
Lifting Capacity

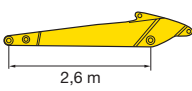
PC350LC-8 MONO BOOM

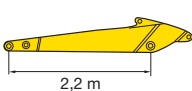
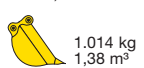
Arm length	A		7,5 m		6,0 m		4,5 m		3,0 m		1,5 m			
	B													
 4,0 m  1.014 kg 1,38 m ³	6,0 m	kg	*3.950	*3.950										
	4,5 m	kg	*4.000	3.800	*6.950	6.750								
	3,0 m	kg	*4.150	3.550	*7.850	6.400	*9.500	9.200	*12.800	*12.800				
	1,5 m	kg	*4.500	3.400	*8.650	6.050	*11.050	8.600	*15.750	13.400				
	0,0 m	kg	*5.050	3.450	*9.250	5.750	*12.000	8.100	*17.000	12.550				
	-1,5 m	kg	*5.850	3.650	9.150	5.550	*12.300	7.800	*17.000	12.150	*9.550	*9.550	*6.750	*6.750
	-3,0 m	kg	6.750	4.100	*9.100	5.500	*11.950	7.700	*16.200	12.150	*15.300	*15.300	*9.700	*9.700
	-4,5 m	kg	*6.750	5.000	*8.000	5.600	*10.700	7.800	*14.250	12.350	*19.750	*19.750	*14.700	*14.700
	 3,2 m  1.014 kg 1,38 m ³	6,0 m	kg	*5.200	5.100	*7.150	6.800							
		4,5 m	kg	*5.350	4.450	*7.700	6.550	*9.050	*9.050					
3,0 m		kg	*5.650	4.100	*8.500	6.250	*10.500	8.950	*14.800	14.050				
1,5 m		kg	*6.200	3.950	*9.150	5.950	*11.800	8.400	*16.450	12.950				
0,0 m		kg	6.550	4.000	9.350	5.750	*12.400	8.050	*17.250	12.400				
-1,5 m		kg	7.050	4.300	9.200	5.600	*12.350	7.850	*16.750	12.300	*9.550	*9.550		
-3,0 m		kg	*7.550	4.950	*8.750	5.600	*11.900	7.900	*15.250	12.450	*17.650	*17.650		
-4,5 m		kg	*7.350	6.400			*9.550	8.050	*12.600	12.600	*16.250	*16.250		
 2,6 m  1.014 kg 1,38 m ³		6,0 m	kg	*7.450	5.800	*7.850	6.700							
		4,5 m	kg	*7.600	5.000	*8.300	6.500	*9.900	9.350	*12.950	*12.950			
	3,0 m	kg	7.300	4.600	*9.000	6.200	*11.250	8.800	*15.450	13.600				
	1,5 m	kg	7.150	4.450	*9.500	5.950	*12.250	8.350						
	0,0 m	kg	7.300	4.500	9.400	5.800	*12.550	8.050	*14.700	12.400				
	-1,5 m	kg	7.950	4.900	9.300	5.700	*12.200	7.950	*16.100	12.450				
	-3,0 m	kg	*7.950	5.800	*8.100	5.800	*10.950	8.000	*14.200	12.650	*17.050	*17.050		
	-4,5 m	kg	*7.350	*7.350			*8.250	*8.250	*10.950	*10.950	*13.000	*13.000		
	 2,2 m  1.014 kg 1,38 m ³	6,0 m	kg	*8.300	6.500	*8.200	6.600	*9.050	*9.050					
		4,5 m	kg	*8.200	5.500	*8.550	6.400	*10.200	9.200	*13.750	*13.750			
3,0 m		kg	8.000	5.000	*9.150	6.150	*11.500	8.700						
1,5 m		kg	7.750	4.800	9.500	5.900	*12.350	8.250						
0,0 m		kg	8.000	4.950	9.350	5.750	*12.500	7.950						
-1,5 m		kg	*8.650	5.400	*9.200	5.700	*11.950	7.900	*15.400	12.450				
-3,0 m		kg	*8.550	6.550			*10.500	8.050	*13.350	12.550	*14.700	*14.700		
-4,5 m		kg	*7.700	*7.700			*6.500	*6.500	*9.800	*9.800				

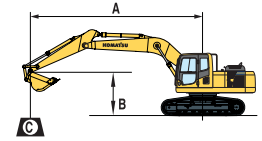

A – Reach from swing center

B – Bucket hook height

C – Lifting capacities, including bucket, bucket linkage and bucket cylinder.

 – Rating over front

















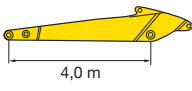

 – Rating over side

 – Rating at maximum reach

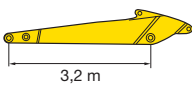
When removing bucket, linkage or cylinder, lifting capacities can be increased by their respective weights.

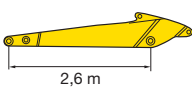
With 700 mm shoes

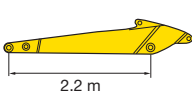
PC350LC-8 TWO-PIECE BOOM

Arm length	A		9,0 m		7,5 m		6,0 m		4,5 m		3,0 m			
	B													
 4,0 m  1.014 kg 1,38 m ³	7,5 m	kg	3.400*	3.400*	4.050*	4.050*	6.350*	6.350*						
	6,0 m	kg	3.250*	3.250*	6.150*	4.900	6.550*	6.550*	6.850*	6.850*				
	4,5 m	kg	3.250*	3.250*	6.400*	4.800	7.150*	6.700	8.350*	8.350*	8.850*	8.850*		
	3,0 m	kg	3.350*	3.300	6.800	4.600	7.900*	6.350	9.650*	9.150	13.100*	13.100*		
	1,5 m	kg	3.550*	3.200	7.150	4.400	8.650*	5.950	11.050*	8.500	15.700*	13.250		
	0,0 m	kg	3.900*	3.250	7.000	4.200	9.150*	5.650	11.900*	8.000	16.800*	12.350		
	-1,5 m	kg	4.400*	3.450	6.850	4.100	9.100	5.500	12.100*	7.700	16.700*	12.000	8.250*	8.250*
	-3,0 m	kg			6.800*	4.100	8.950*	5.450	11.650*	7.650	15.750*	12.000		
	 3,2 m  1.014 kg 1,38 m ³	7,5 m	kg	4.550*	4.550*			7.200*	6.800	7.650*	7.650*			
		6,0 m	kg	4.350*	4.350*	4.500*	4.500*	7.300*	6.750	8.150*	8.150*	8.650*	8.650*	
4,5 m		kg	4.400*	4.150	6.950*	4.650	7.800*	6.500	9.300*	9.300*	11.850*	11.850*	17.000*	17.000*
3,0 m		kg	4.550*	3.850	7.200*	4.500	8.500*	6.150	10.600*	8.850	14.300*	13.900		
1,5 m		kg	4.900*	3.750	7.100	4.350	9.100*	5.850	11.750*	8.300	16.350*	12.800		
0,0 m		kg	5.450*	3.800	7.000	4.250	9.300	5.650	12.250*	7.950	17.000*	12.250		
-1,5 m		kg	6.400*	4.100	6.950	4.200	9.150	5.550	12.100*	7.750	16.350*	12.150		
-3,0 m		kg					8.450*	5.550	11.150*	7.800				
 2,6 m  1.014 kg 1,38 m ³		7,5 m	kg	6.800*	6.800*				8.550*	8.550*				
		6,0 m	kg	6.550*	5.450			7.950*	6.650	8.950*	8.950*	10.800*	10.800*	
	4,5 m	kg	6.550*	4.700	6.600*	4.600	8.350*	6.400	10.050*	9.250	13.250*	13.250*		
	3,0 m	kg	6.800*	4.350	7.300	4.500	8.950*	6.150	11.250*	8.700				
	1,5 m	kg	6.900	4.250	7.150	4.400	9.400*	5.850	12.150*	8.250				
	0,0 m	kg	7.100	4.350	7.050	4.300	9.350	5.700	12.350*	7.950				
	-1,5 m	kg	7.400*	4.700			9.150*	5.650	11.900*	7.850	15.600*	12.250		
	-3,0 m	kg												
	 2,2 m  1.014 kg 1,38 m ³	7,5 m	kg	8.700*	7.950				9.000*	9.000*	10.200*	10.200*		
		6,0 m	kg	8.250*	6.100			8.250*	6.550	9.350*	9.350*	11.600*	11.600*	15.700*
4,5 m		kg	8.050*	5.200			8.550*	6.350	10.350*	9.100	13.500*	13.500*		
3,0 m		kg	7.650	4.750			9.150*	6.050	11.500*	8.550				
1,5 m		kg	7.500	4.600	7.100	4.350	9.450	5.800	12.250*	8.100				
0,0 m		kg	7.700	4.700			9.300	5.650	12.300*	7.850				
-1,5 m		kg	8.000*	5.150			8.900*	5.650	11.650*	7.800	14.850*	12.250		
-3,0 m		kg												

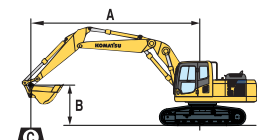

A – Reach from swing center

B – Bucket hook height

C – Lifting capacities, including bucket, bucket linkage and bucket cylinder.

 – Rating over front

 – Rating over side

















 – Rating at maximum reach

When removing bucket, linkage or cylinder, lifting capacities can be increased by their respective weights.

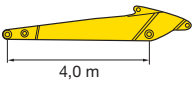
With 700 mm shoes

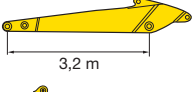
* Load is limited by hydraulic capacity rather than tipping. Ratings are based on SAE Standard No. J1097. Rated loads do not exceed 87% of hydraulic lift capacity or 75% of tipping load.

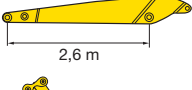
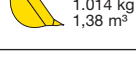
PC350NLC-8 MONO BOOM

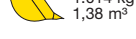
Arm length	A		7,5 m		6,0 m		4,5 m		3,0 m		1,5 m			
	B													
 4,0 m  1.014 kg 1,38 m ³	6,0 m	kg	*3.950	3.900										
	4,5 m	kg	*4.000	3.400	*6.950	6.150								
	3,0 m	kg	*4.150	3.150	*7.850	5.800	*9.500	8.350	*12.800	*12.800				
	1,5 m	kg	*4.500	3.050	*8.650	5.450	*11.050	7.750	*15.750	12.000				
	0,0 m	kg	*5.050	3.050	9.200	5.150	*12.000	7.300	*17.000	11.200				
	-1,5 m	kg	*5.850	3.250	9.050	5.000	*12.300	7.000	*17.000	10.800	*9.550	*9.550	*6.750	*6.750
	-3,0 m	kg	6.650	3.650	8.950	4.900	*11.950	6.900	*16.200	10.800	*15.300	*15.300	*9.700	*9.700
	-4,5 m	kg	*6.750	4.450	*8.000	5.000	*10.700	7.000	*14.250	11.000	*19.750	*19.750	*14.700	*14.700
 3,2 m  1.014 kg 1,38 m ³	6,0 m	kg	*5.200	4.600	*7.150	6.200								
	4,5 m	kg	*5.350	4.000	*7.700	5.950	*9.050	8.650						
	3,0 m	kg	*5.850	3.650	*8.500	5.650	*10.500	8.100	*14.800	12.650				
	1,5 m	kg	*6.200	3.550	*9.150	5.350	*11.800	7.600	*16.400	11.600				
	0,0 m	kg	6.450	3.600	9.200	5.150	*12.400	7.200	*17.250	11.100				
	-1,5 m	kg	6.950	3.850	9.050	5.000	*12.350	7.050	*16.750	10.950	*9.550	*9.550		
	-3,0 m	kg	*7.550	4.450	*8.750	5.050	*11.500	7.050	*15.250	11.100	*17.650	*17.650		
	-4,5 m	kg	*7.350	5.750			*9.550	7.250	*12.600	11.350	*16.250	*16.250		
 2,6 m  1.014 kg 1,38 m ³	6,0 m	kg	*7.450	5.250	*7.850	6.100								
	4,5 m	kg	*7.600	4.500	*8.300	5.900	*9.900	8.500	*12.950	*12.950				
	3,0 m	kg	7.200	4.100	*9.000	5.600	*11.250	7.950	*15.450	12.250				
	1,5 m	kg	7.050	4.000	9.450	5.350	*12.250	7.500						
	0,0 m	kg	7.200	4.050	9.250	5.200	*12.550	7.250	*14.700	11.050				
	-1,5 m	kg	7.850	4.400	9.150	5.100	*12.200	7.100	*16.100	11.100				
	-3,0 m	kg	*7.950	5.200	*8.100	5.200	*10.950	7.200	*14.200	11.300	*17.050	*17.050		
	-4,5 m	kg	*7.350	7.100			*8.250	7.500	*10.950	*10.950	*13.000	*13.000		
 2,2 m  1.014 kg 1,38 m ³	6,0 m	kg	*8.300	5.900	*8.200	6.000	*9.050	8.850						
	4,5 m	kg	*8.200	5.000	*8.550	5.800	*10.200	8.350	*13.750	13.150				
	3,0 m	kg	7.850	4.500	*9.150	5.500	*11.500	7.850						
	1,5 m	kg	7.650	4.350	9.400	5.300	*12.350	7.400						
	0,0 m	kg	7.900	4.450	9.200	5.150	*12.500	7.150						
	-1,5 m	kg	*8.650	4.850	*9.150	5.100	*11.950	7.100	*15.400	11.150				
	-3,0 m	kg	*8.550	5.900			*10.500	7.200	*13.350	11.350	*14.700	*14.700		
	-4,5 m	kg	*7.700	*7.700			*6.500	*6.500	*9.800	*9.800				

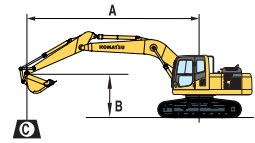

A – Reach from swing center

B – Bucket hook height

C – Lifting capacities, including bucket, bucket linkage and bucket cylinder.

 – Rating over front















 – Rating over side

 – Rating at maximum reach

When removing bucket, linkage or cylinder, lifting capacities can be increased by their respective weights.

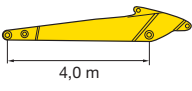
With 600 mm shoes

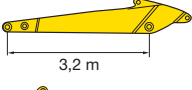
PC350NLC-8 TWO-PIECE BOOM

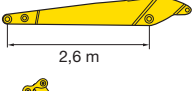
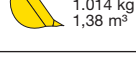
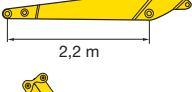
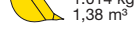
Arm length	A		9,0 m		7,5 m		6,0 m		4,5 m		3,0 m			
	B													
 4,0 m  1.014 kg 1,38 m ³	7,5 m	kg	3.400*	3.400*	4.050*	4.050*	6.300*	6.300*						
	6,0 m	kg	3.250*	3.250*	6.100*	4.450	6.500*	6.350	6.850*	6.850*				
	4,5 m	kg	3.250*	3.150	6.350*	4.300	7.050*	6.050	8.300*	8.300*	8.850*	8.850*		
	3,0 m	kg	3.350*	2.900	6.700*	4.100	7.850*	5.700	9.600*	8.250	12.950*	12.950		
	1,5 m	kg	3.550*	2.800	7.050	3.900	8.550*	5.300	10.900*	7.600	15.550*	11.750		
	0,0 m	kg	3.900*	2.800	6.850	3.700	9.050*	5.000	11.750*	7.100	16.550*	10.850		
	-1,5 m	kg	4.400*	3.000	6.700	3.600	8.950	4.800	11.900*	6.750	16.500*	10.500	8.250*	8.250*
	-3,0 m	kg			6.700*	3.600	8.800*	4.750	11.500*	6.700	15.500*	10.500		
 3,2 m  1.014 kg 1,38 m ³	7,5 m	kg	4.550*	4.550*			7.150*	6.200	7.600*	7.600*				
	6,0 m	kg	4.350*	4.250	4.500*	4.200	7.250*	6.100	8.100*	8.100*	8.650*	8.650*		
	4,5 m	kg	4.400*	3.700	6.850*	4.150	7.700*	5.850	9.250*	8.550	11.800*	11.800*	16.900*	16.900*
	3,0 m	kg	4.550*	3.400	7.150*	4.000	8.400*	5.500	10.500*	7.950	14.150*	12.450		
	1,5 m	kg	4.900*	3.250	6.950	3.850	9.000*	5.200	11.600*	7.400	16.150*	11.300		
	0,0 m	kg	5.450*	3.300	6.850	3.700	9.100	5.000	12.050*	7.000	16.750*	10.750		
	-1,5 m	kg	6.400*	3.600	6.800	3.650	8.950	4.850	11.900*	6.800	16.100*	10.650		
	-3,0 m	kg					8.300*	4.900	10.950*	6.850				
 2,6 m  1.014 kg 1,38 m ³	7,5 m	kg	6.800*	6.200				8.500*	8.500*					
	6,0 m	kg	6.550*	4.900			7.850*	6.000	8.900*	8.900*	10.750*	10.750*		
	4,5 m	kg	6.550*	4.200	6.600*	4.100	8.250*	5.800	9.950*	8.350	13.150*	13.150*		
	3,0 m	kg	6.800*	3.850	7.150	4.000	8.850*	5.450	11.150*	7.800				
	1,5 m	kg	6.750	3.700	7.000	3.850	9.300*	5.200	12.000*	7.300				
	0,0 m	kg	6.900	3.800	6.900	3.800	9.150	5.000	12.200*	7.000				
	-1,5 m	kg	7.300*	4.150			9.050*	4.950	11.750*	6.900	15.350*	10.750		
	-3,0 m	kg												
 2,2 m  1.014 kg 1,38 m ³	7,5 m	kg	8.650*	7.200				8.900*	8.900*	10.200*	10.200*			
	6,0 m	kg	8.150*	5.500			8.150*	5.900	9.250*	8.750	11.550*	11.550*	15.700*	15.700*
	4,5 m	kg	7.950*	4.650			8.450*	5.700	10.250*	8.200	13.400*	13.000		
	3,0 m	kg	7.500	4.200			9.000*	5.400	11.350*	7.650				
	1,5 m	kg	7.350	4.050	6.950	3.850	9.300	5.150	12.050*	7.200				
	0,0 m	kg	7.500	4.150			9.100	5.000	12.100*	6.950				
	-1,5 m	kg	7.850*	4.550			8.800*	4.950	11.450*	6.900	14.600*	10.750		
	-3,0 m	kg												

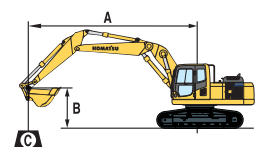

A – Reach from swing center

B – Bucket hook height

C – Lifting capacities, including bucket, bucket linkage and bucket cylinder.

 – Rating over front

 – Rating over side

 – Rating at maximum reach

When removing bucket, linkage or cylinder, lifting capacities can be increased by their respective weights.

With 600 mm shoes

* Load is limited by hydraulic capacity rather than tipping. Ratings are based on SAE Standard No. J1097. Rated loads do not exceed 87% of hydraulic lift capacity or 75% of tipping load.

Super Long Front Specification

Specifications PC350LC-8 Super Long Front

WORK EQUIPMENT

Boom	
Length (a)	12.430 mm
Height (b)	1.745 mm
Weight	4.650 kg
Arm	
Length (c)	10.700 mm
Height (d)	1.080 mm
Weight	2.550 kg

BUCKETS

Max. bucket weight	420 kg
Max. bucket capacity	0,47 m ³
	(Material density 1,8 ton/m ³ SAE)
Max. bucket width	2.100 mm
Bucket linkage class	PC240

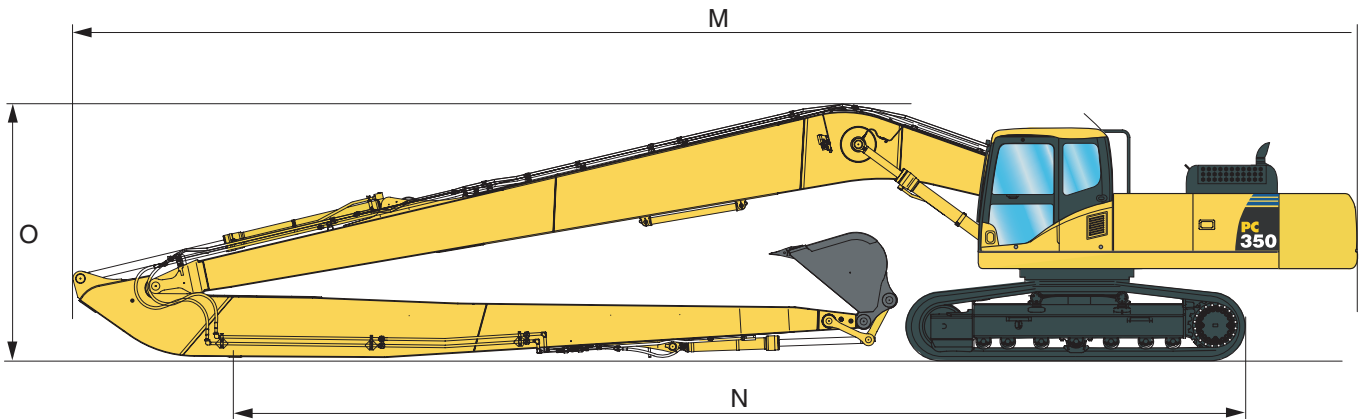
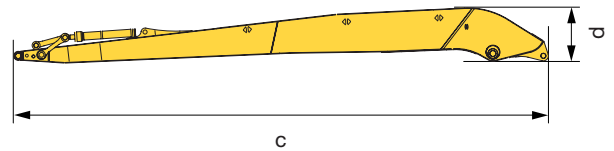
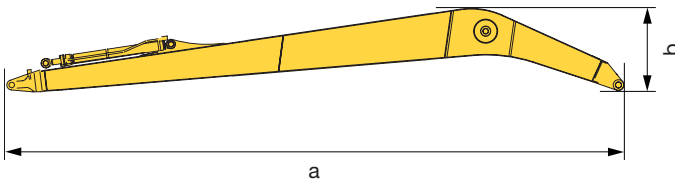

TRANSPORT DIMENSIONS

M	Transport length	17.220 mm
N	Length on ground (transport)	14.475 mm
O	Overall height (to top of boom)	3.405 mm

OPERATING WEIGHT (APPR.)

PC350LC-8		
Triple grouser shoes	Operating weight	Ground pressure
700 mm	41.210 kg	0,59 kg/cm ²
800 mm	41.590 kg	0,59 kg/cm ²
850 mm	41.780 kg	0,59 kg/cm ²

Operating weight, including Super Long Front work equipment, bucket, operator, lubricant, coolant, full fuel tank and the standard equipment.

Working range PC350LC-8 Super Long Front

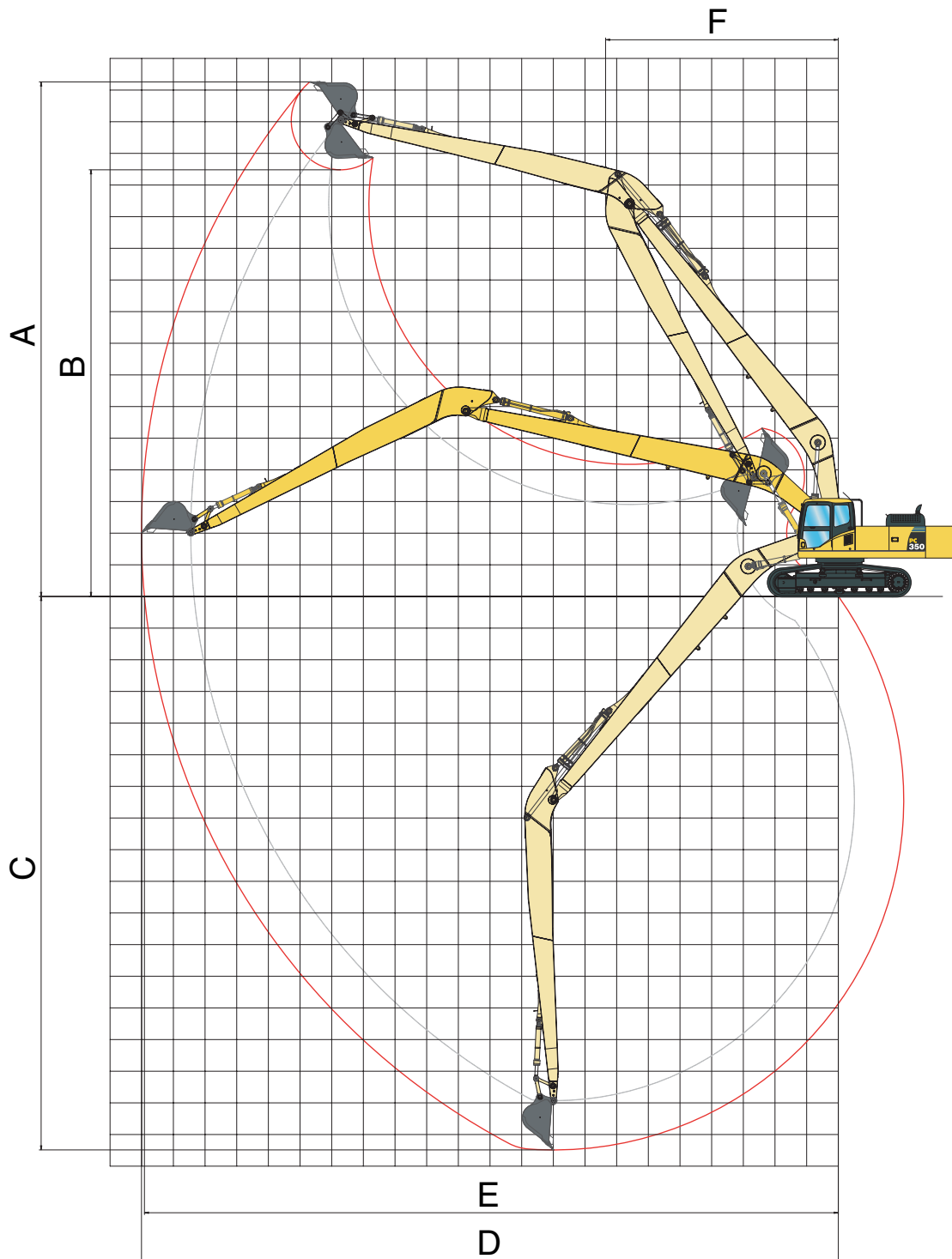

SUPER LONG FRONT

A	Max. digging height	16.260 mm
B	Max. dumping height	13.480 mm
C	Max. digging depth	17.485 mm
D	Max. digging reach	22.010 mm
E	Max. digging reach at ground level	21.915 mm
F	Min. swing radius	7.350 mm

Super Long Front Specification

Lifting capacity PC350LC-8 Super Long Front

A – Reach from swing center

B – Bucket hook height

C – Lifting capacities, including bucket (450 kg)

 – Rating over front







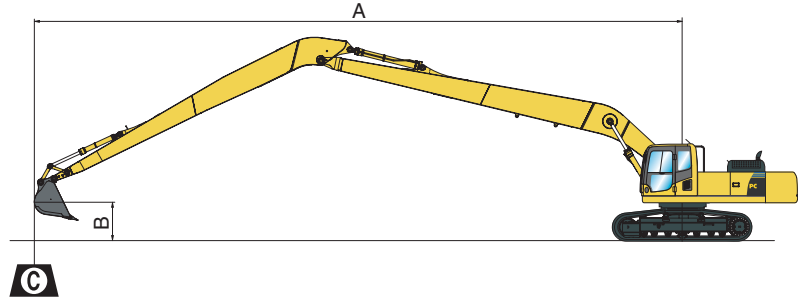





 – Rating over side

 – Rating at maximum reach

When removing bucket, linkage or cylinder, lifting capacities can be increased by their respective weights.



With 800 mm shoes

A			20,0 m		16,0 m		12,0 m		8,0 m		4,0 m	
												
12,0 m kg	800 *	800 *										
8,0 m kg	800 *	800 *			1.750 *	1.750 *						
4,0 m kg	900 *	900 *			2.050 *	2.050 *	2.700 *	2.700 *				
0,0 m kg	1.050 *	1.050	1.750 *	1.200	2.300 *	2.050	3.350 *	3.350 *	5.650 *	5.650 *	3.000 *	3.000 *
- 4,0 m kg	1.400 *	1.100			2.500 *	1.750	3.750 *	2.900	6.350 *	5.200	4.050 *	4.050 *
- 8,0 m kg	1.850 *	1.300			2.450 *	1.650	3.750 *	2.700	6.150 *	5.000	5.150 *	5.150 *
- 12,0 m kg	1.950 *	1.900							5.050 *	5.050 *	8.950 *	8.950 *

* Load is limited by hydraulic capacity rather than tipping. Ratings are based on SAE Standard No. J1097.
 Rated loads do not exceed 87% of hydraulic lift capacity or 75% of tipping load.
 Lifting capacity table is published for guidance only, the machine is not intended for use as a crane.



Hydraulic Excavator

PC350LC/NLC-8

Standard and Optional Equipment

ENGINE

Komatsu SAA6D114E-3 turbocharged common rail direct injection diesel engine	●
EU Stage IIIA/EPA Tier III compliant	●
Suction type cooling fan with radiator fly screen	●
Automatic engine warm-up system	●
Engine overheat prevention system	●
Fuel control dial	●
Auto-deceleration function	●
Engine key stop	●
Engine ignition can be password secured on request	●
Alternator 24 V/60 A	●
Starter motor 24 V/11 kW	●
Batteries 2 × 12 V/140 Ah	●
Diesel particulate filter	○

HYDRAULIC SYSTEM

Electronic closed-centre load sensing (E-CLSS) hydraulic system (HydrauMind)	●
Pump and engine mutual control (PEMC) system	●
5-working mode selection system; power mode, economy mode, breaker mode, attachment mode and lifting mode	●
PowerMax function	●
Adjustable PPC wrist control levers for arm, boom, bucket and swing, with sliding proportional control for attachments and 3 auxiliary buttons	●
Prepared for hydraulic quick-coupler (not with Super Long Front)	●
One additional hydraulic circuit (standard with Super Long Front)	○
Additional hydraulic functions (not with Super Long Front)	○

UNDERCARRIAGE

Track roller guards	●
Track frame under-guards	●
LC and NLC undercarriages	○
600, 700, 800, 850 mm triple grouser track-shoes	○
Full length track roller guards	○

CABIN

Reinforced safety SpaceCab™; highly pressurised and tightly sealed hyper viscous mounted cab with tinted safety glass windows, large roof window with sun shade, pull-up type front window with locking device, removable lower window, front window wiper with intermittent feature, sun roller blind, cigarette lighter, ashtray, luggage shelf, floor mat	●
Heated air suspension seat with lumbar support, height adjustable arm rests and retractable seat belt	●
Automatic climate control system	●
12 Volt power supply	●
Beverage holder and magazine rack	●
Hot and cool box	●
Radio	●
Lower wiper	○
Rain visor (not with OPG)	○

SERVICE AND MAINTENANCE

Automatic fuel line de-aeration	●
Double element type air cleaner with dust indicator and auto dust evacuator	●
KOMTRAX™ - Komatsu satellite monitoring system	●
Multi-function video compatible colour monitor with Equipment Management and Monitoring System (EMMS) and efficiency guidance	●
Toolkit and spare parts for first service	●
Automatic greasing system	○
Service points	○

WORK EQUIPMENT

Mono boom	○
Two-piece boom	○
Super Long Front boom and arm (22 m)	○
2,2 m; 2,6 m; 3,2 m; 4,0 m arms	○
Bucket linkage with lifting eye	○
Komatsu buckets	○
Komatsu breakers	○

SAFETY EQUIPMENT

Rear view camera system	●
Electric horn	●
Overload warning device	●
Lockable fuel cap and covers	●
Audible travel alarm	●
Boom safety valves	●
Large handrails, rear-view mirrors	●
Battery main switch	●
Arm safety valve (not with Super Long Front)	○
OPG Level II front guard (FOPS)	○
OPG Level II top guard (FOPS)	○

DRIVES AND BRAKES

Hydrostatic, 3-speed travel system with automatic shift and planetary gear type final drives, and hydraulic travel and parking brakes	●
PPC control levers and pedals for steering and travel	●

LIGHTING SYSTEM

Working lights: 2 revolving frame, 2 cab roof (front), 1 boom (l.h.)	●
Additional working lights: 2 cab roof (front), 1 cab roof (rear), 1 boom (r.h.), 1 counterweight (rear), 1 beacon	○

OTHER EQUIPMENT

Standard counterweight	●
Heavy counterweight (with Super Long Front)	●
Remote greasing for swing circle and pins	●
Electric refuelling pump with automatic shut off function	●
Standard colour scheme and decals	●
Parts book and operator manual	●
Biodegradable oil for hydraulic system	○
Customised paint	○

Further equipment on request

- standard equipment
- optional equipment

Your Komatsu partner:

KOMATSU

Komatsu Europe International NV
 Mechelsesteenweg 586
 B-1800 VILVOORDE (BELGIUM)
 Tel. +32-2-255 24 11
 Fax +32-2-252 19 81
www.komatsu.eu

UESS12403 04/2009

Materials and specifications are subject to change without notice.
KOMATSU is a trademark of Komatsu Ltd. Japan.